

SEQUE

DESIGNS

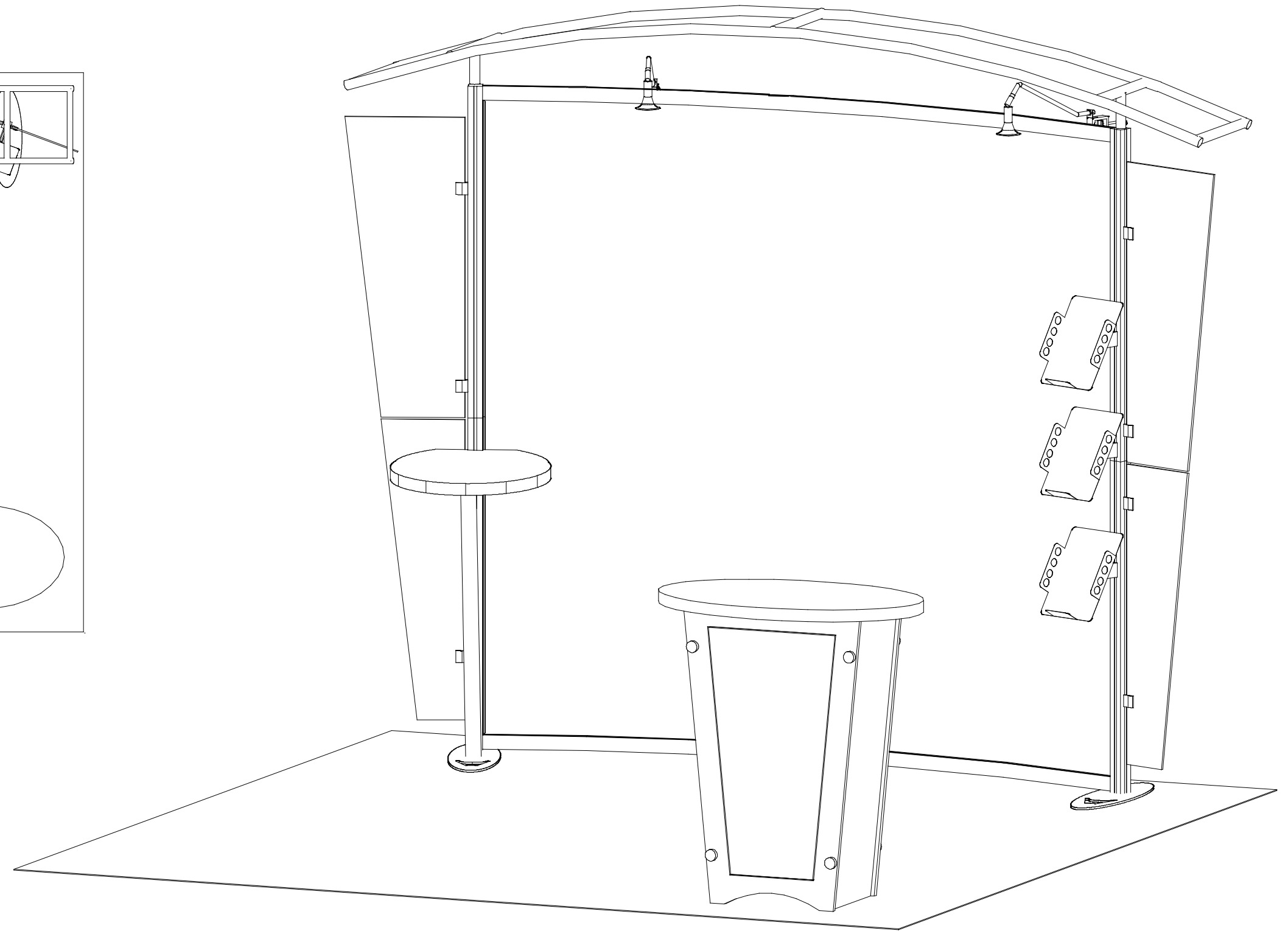
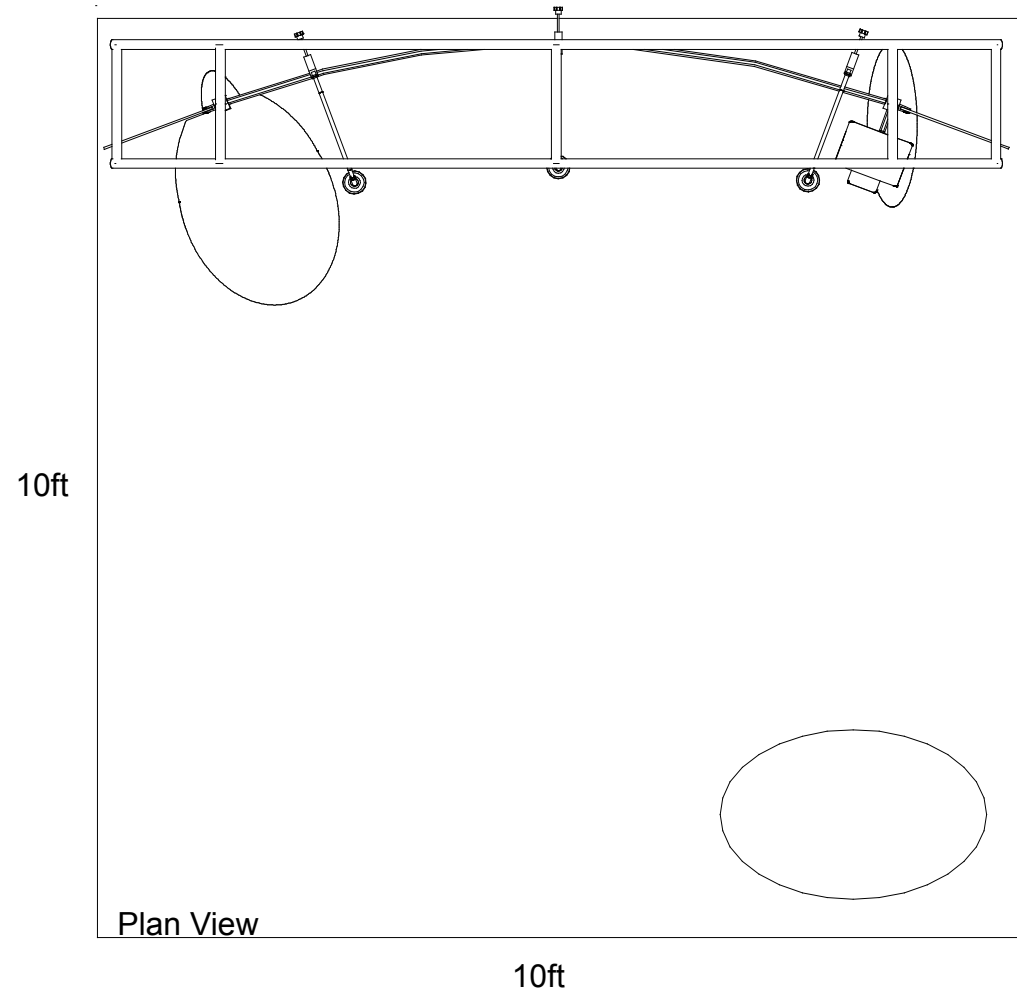

WHEN DISASSEMBLING ALUMINUM EXTRUSION, TIGHTEN ALL SETSCREWS AND LOCKS TO PREVENT LOSS DURING SHIPPING

visionary™ DESIGNS

Using Your Setup Instructions

The Visionary Designs Setup Instructions are created specifically for your configuration. They are laid out sequentially, including an exploded view of the entire display, and then a logical series of detailed steps to assemble the main structure and components. We encourage you to study the instructions **before** attempting to assemble your exhibit.

Each page reminds you to tighten the setscrews after disassembling your exhibit to prevent loss of the locks and setscrews (see below in RED). This is **VERY IMPORTANT**.

Cleaning and Packing Your Display

- 1) Use care when cleaning aluminum extrusion or acrylic inserts. Use only non-abrasive cleaners.
- 2) When cleaning laminate inserts or countertops, use mild cleansers and a soft material such as cotton.
- 3) Keep all display components away from extreme heat and long exposure to sunlight to avoid warping and fading.
- 4) Retain all packing material. It will make re-packing much easier and will reduce the likelihood of shipping damage.



The Tool

Most Visionary Designs exhibits can be assembled with the supplied Hex Key Tool. Occasionally, a flat head screwdriver may be required.



Typical Connection

Most horizontal extrusion connections have a patented expandable lock. This lock inserts into the groove of an opposing extrusion. Tightening the lock with the Hex Key Tool expands the lock and creates a strong positive connection.



Typical Connection (cont'd)

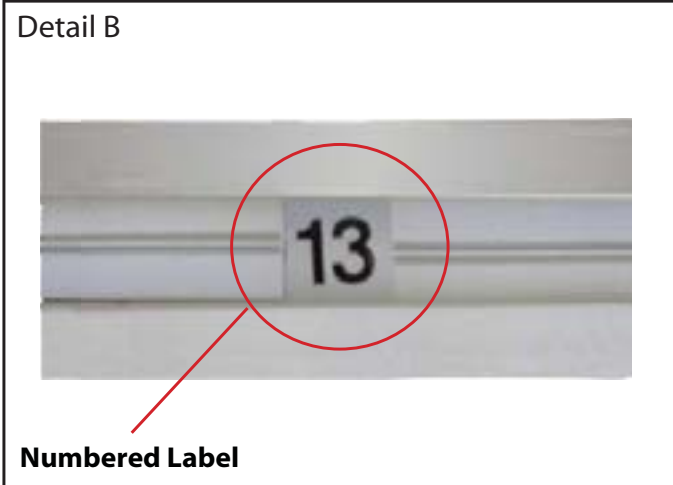

Numbered Label

Each extrusion contains a numbered label which corresponds with setup instructions. The label is located within a groove of the extrusion (when possible). With Visionary Designs the labels contain Black numbers unless otherwise specified.



Horizontal Inline Connection (remove only one setscrew)

Remove only (1) setscrew when disassembling. Replace setscrew in extrusion after assembling it. Before packing, replace setscrew in extrusion to avoid losing it.

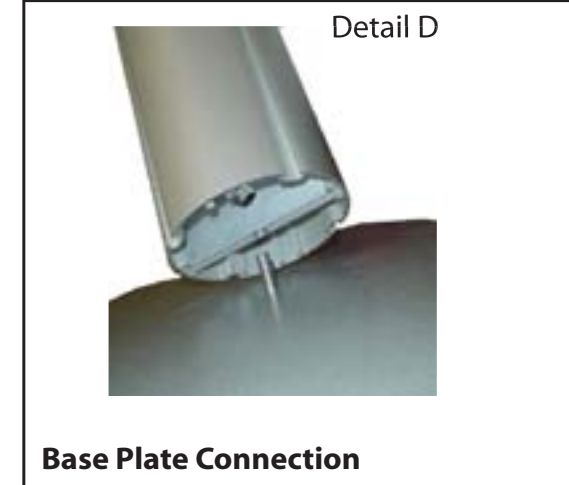

Base Plate Connection

Attach base plate to round or square vertical extrusion using the bolt provided. Be careful not to strip the threads.

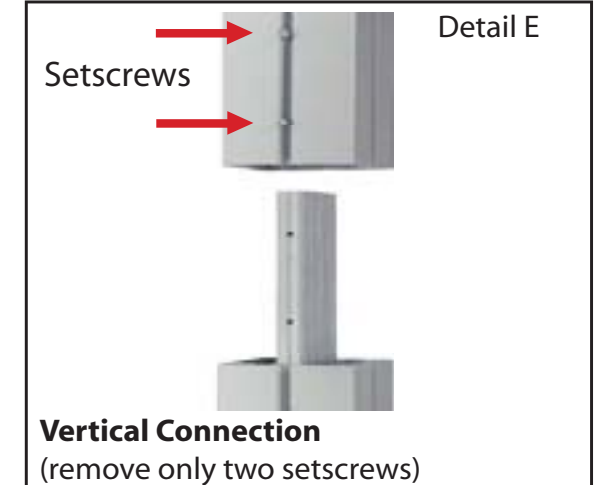

Vertical Connection
(remove only two setscrews)

When vertical extrusions are packed in portable cases rather than crates or tubs, they must be broken down into smaller sections which then require assembly.

Remove only (2) setscrews when disassembling. Replace setscrews in extrusion after assembling it. Before packing, replace setscrews in extrusion to avoid losing them.

WHEN DISASSEMBLING ALUMINUM EXTRUSION, TIGHTEN ALL SETSCREWS AND LOCKS TO PREVENT LOSS DURING SHIPPING

SEG Graphic: To Ensure Proper Fit

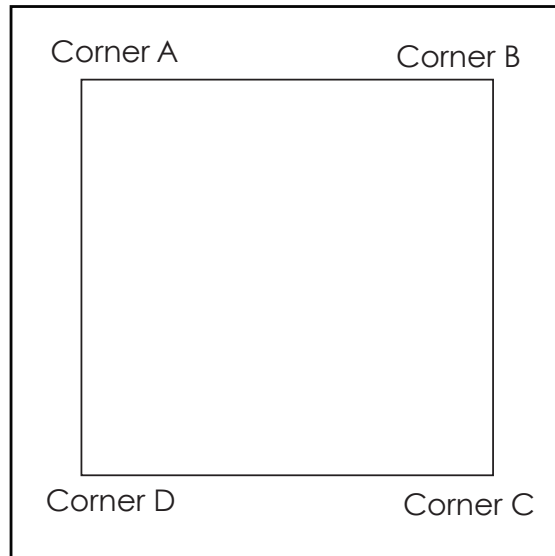

It is important to first insert graphic into each alternater corner then to the sides of the frame.
If this is not done, graphic will not fit into the frame correctly.

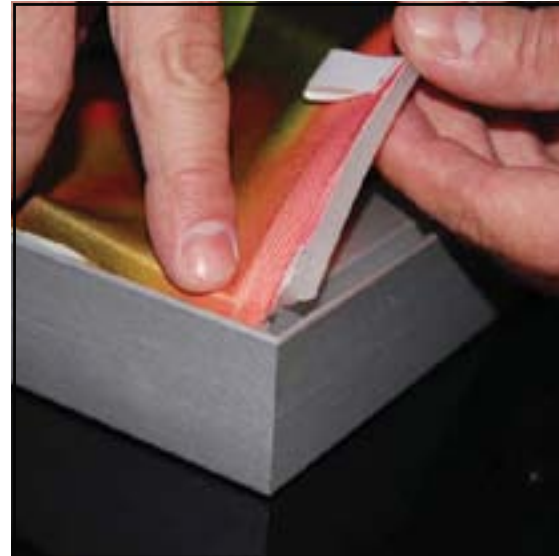

Step 1
Insert corner A.
Turn edge of graphic so silicon welt is perpendicular to face of graphic. Insert narrow side of welt with fabric to outside into the channel.
Repeat for other side of this corner.



Step 2
Repeat Step 1 for opposite corner C, then insert corner B, followed by corner corner D, to complete the installation of the corners.



Step 3
Once all corners are inserted, press one silicon edge into channel from corners and work toward the center. Make sure welt is fully inserted into channel. Continue until all sides are done. Smooth out edges of graphic.

Graphic Removal

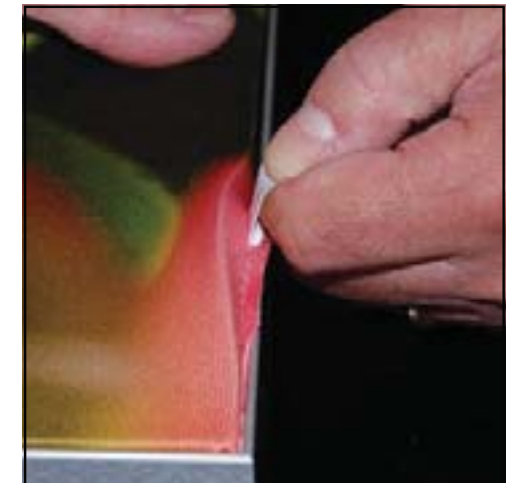

To remove the graphic from the frame, locate the fabric pull tab. Gently pull up on the tab to remove the fabric.

WHEN DISASSEMBLING ALUMINUM EXTRUSION, TIGHTEN ALL SETSCREWS AND LOCKS TO PREVENT LOSS DURING SHIPPING

866.652.2100

Part Number	Qty for Step	Description
1/1a	1/1	Base Plates
2/2a	2	42" h Lower Vertical extrusion
3/3a	2	42" h Upper Vertical extrusion
4a/4b	2	42.886" Lower Horizontal w/ SEG extrusion
5a/5b	2	42.886" Upper Horizontal w/ SEG extrusion
6	1	40" Round Oval extrusion - Workstation Counter support
7	1	19" Tapered Horizontal extrusion - Workstation Counter support

Steps

- 1) Attach 42" h Vertical extrusions [2 and 2a] and 40" Round Oval extrusion - Workstation Counter support [6] to the Oval base plates [1 and 1a].
- 2) Attach 42" h Upper Vertical extrusions [3 and 3a] atop of Lower Vertical extrusions [2 and 2a].
- 3) Assemble all Horizontal extrusions [4a to 4b and 5a to 5b].
- 4) Attach 19" Tapered Horizontal extrusion - Workstation Counter support [7] between 84" h Vertical [2/3] and Tapered Vertical extrusion [6].
- 5) Attach 84" Lower Horizontal assemblies [4a/4b] between Vertical assemblies [2/3 and 2a/3a] as shown.
- 6) Attach 84" Upper Horizontal assemblies [5a/5b] between Vertical assemblies [2/3 and 2a/3a] as shown.
- 7) Place Counter top with Thumbscrews onto horizontal extrusion [7].

NOTE: SEG Extrusion on Lower Horizontals must face UP.

NOTE: SEG Extrusion on Upper Horizontals must face DOWN.

Monitor Mount Attachment

Attach back plate to connectors on vertical extrusion using screws. Then attach top plate and tighten setscrews to secure.

* = Indicates A10 clamp
 Note: A10 Clamps must stay attached to vertical extrusions

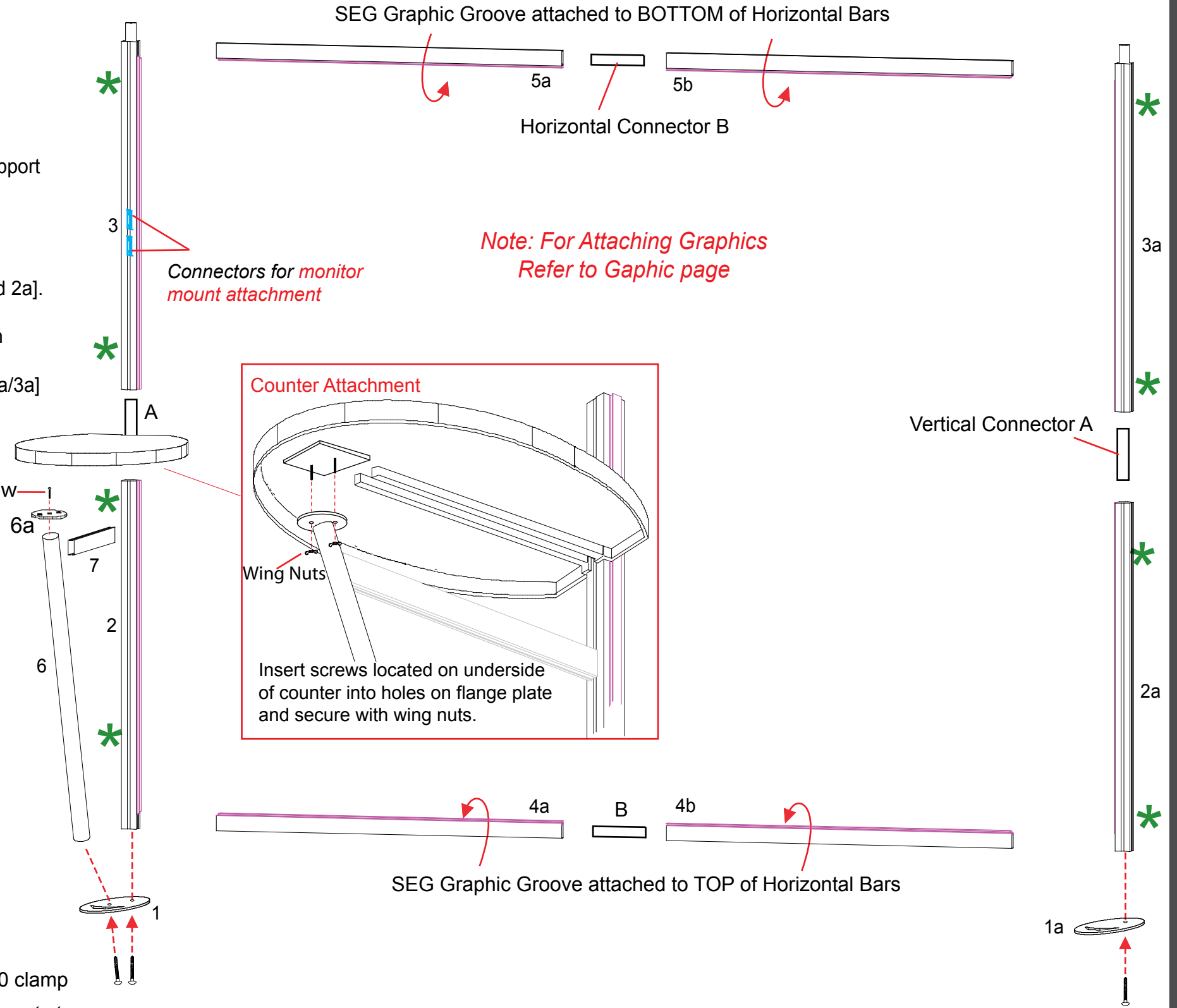

WHEN DISASSEMBLING ALUMINUM EXTRUSION, TIGHTEN ALL SETSCREWS AND LOCKS TO PREVENT LOSS DURING SHIPPING

866.652.2100

A10 Clamp Attachment
(If Removed)

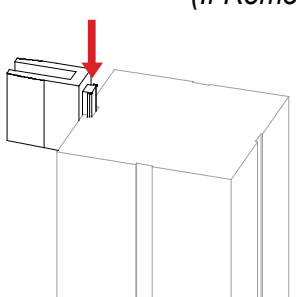

Slide connector on back of A10 clamp into groove of extrusion.

When desired location is found, tighten set screw to secure.

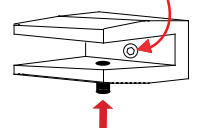

Tighten plastic knob to secure wing in place.

Light Connection

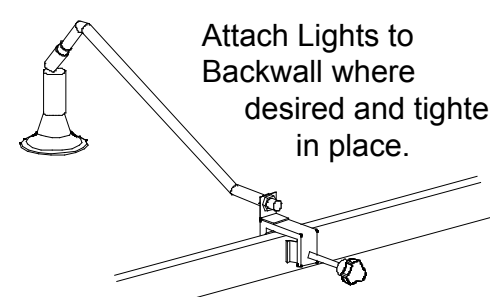

Attach Lights to Backwall where desired and tighten in place.

*** Literature Rack Attachment**

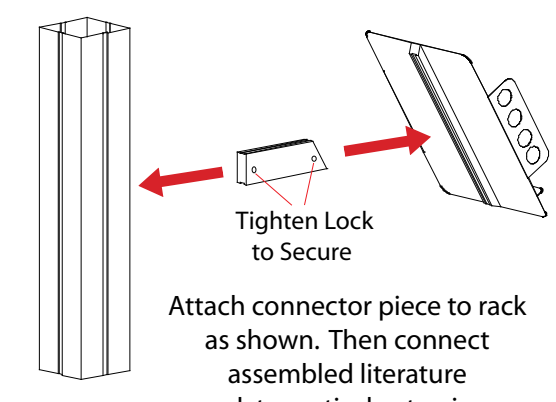

Tighten Lock to Secure

Attach connector piece to rack as shown. Then connect assembled literature rack to vertical extrusion.

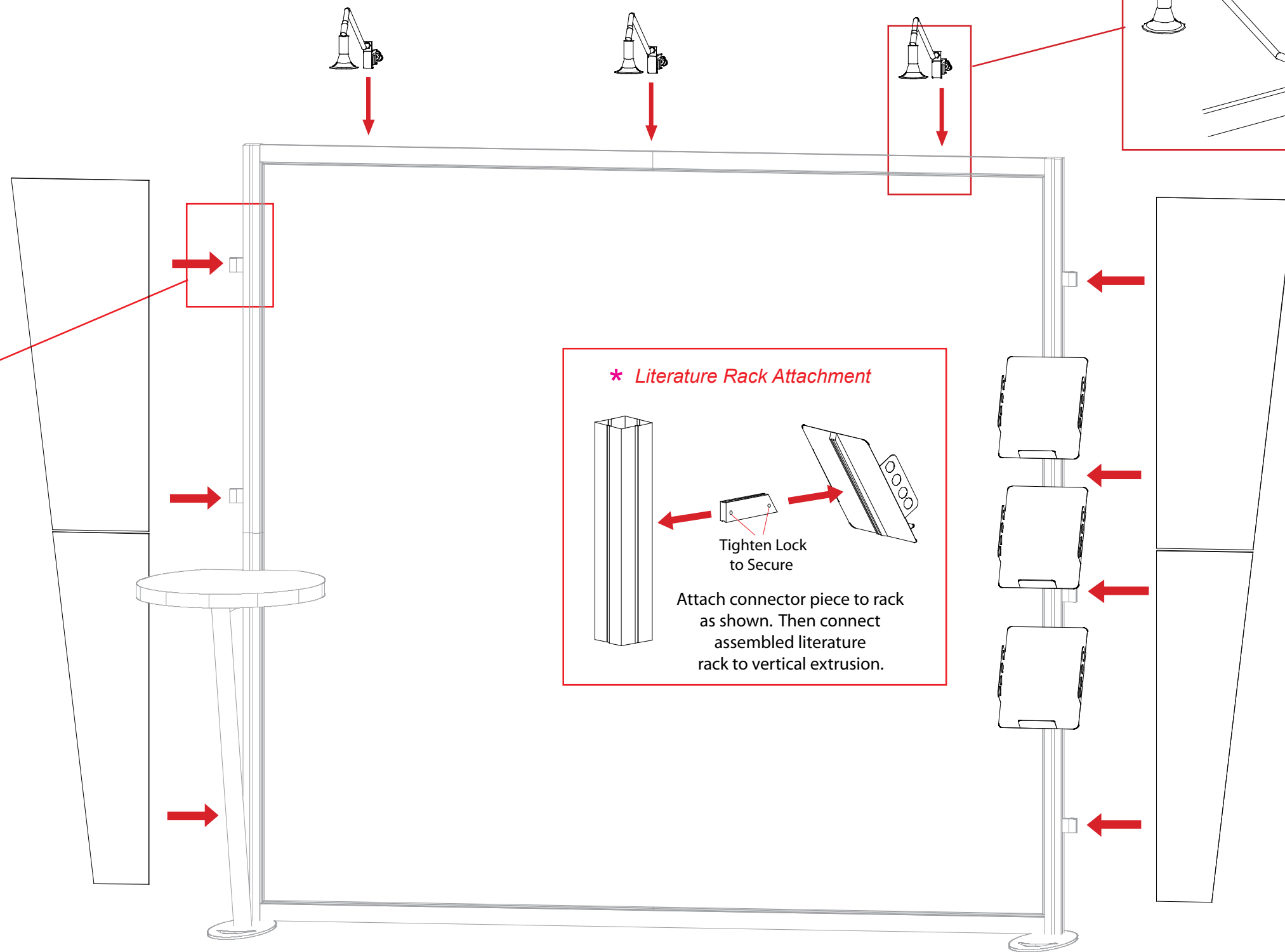

WHEN DISASSEMBLING ALUMINUM EXTRUSION, TIGHTEN ALL SETSCREWS AND LOCKS TO PREVENT LOSS DURING SHIPPING



Using Your Setup Instructions

The Aero Overhead Sign Setup Instructions are created specifically for your configuration. They include an exploded view of the frame which is sequentially numbered. We encourage you to study the instructions before attempting to assemble your exhibit.

Connections are kept very simple: no tools. Everything assembles with push-button connectors and pre-connected horizontal sections.

Cleaning and Packing Your Display

- 1) Use care when cleaning aluminum extrusion or acrylic inserts. Use only non-abrasive cleaners.
- 2) Retain all packing material. It will make re-packing much easier and will reduce the likelihood of shipping damage.

- Steps:
- 1) Connect canopy pieces together as shown.
 - 2) Apply pillow case graphic to assembled canopy

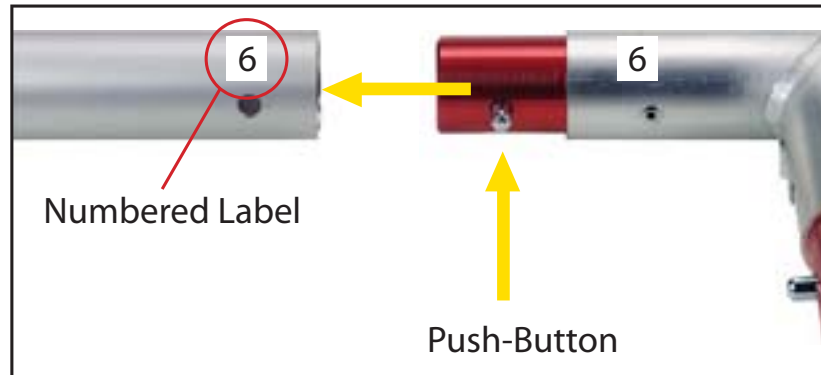
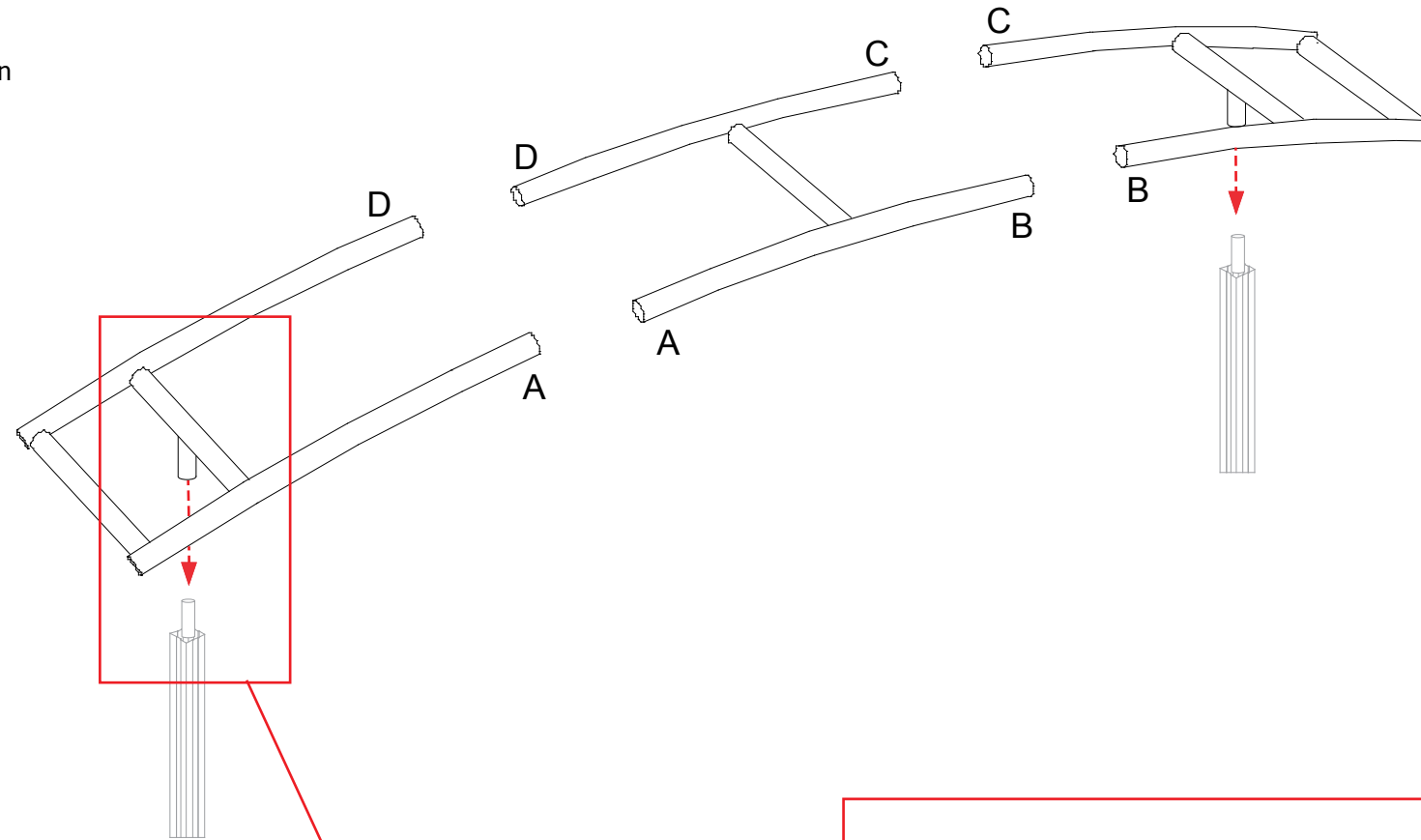

Connections are made by holding the button down and sliding the red tube into opposing tube until the connection is made. To disassemble push button and pull or twist extrusions apart.

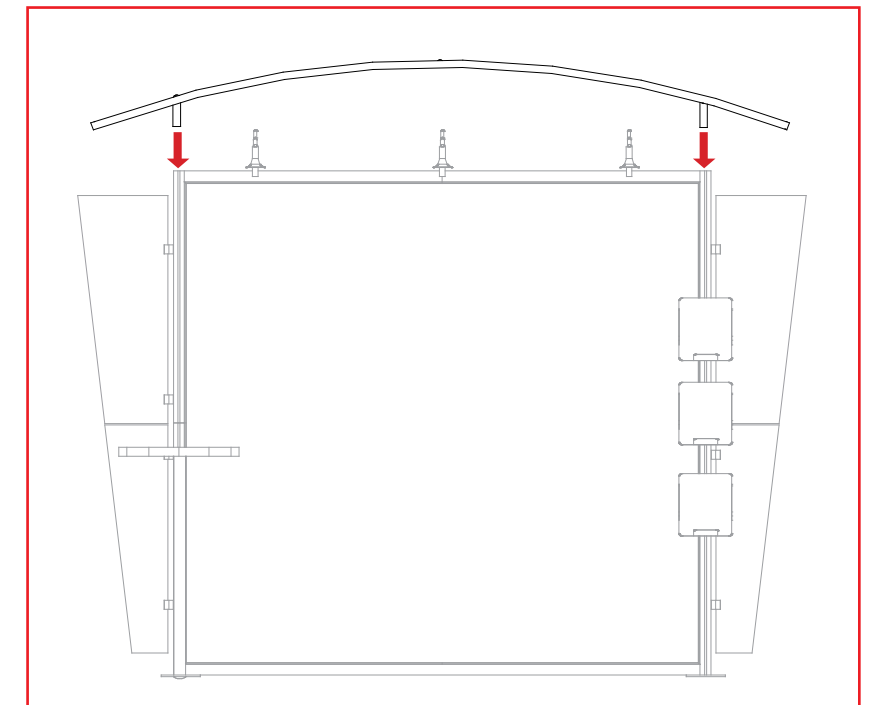
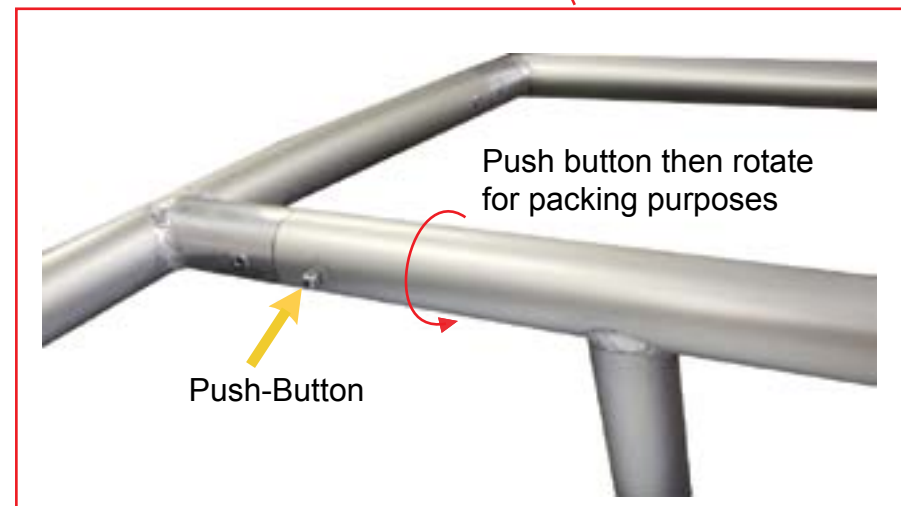
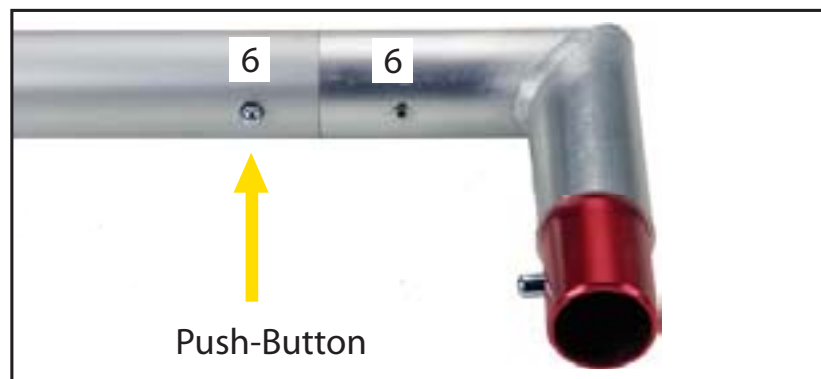

WHEN DISASSEMBLING ALUMINUM EXTRUSION, TIGHTEN ALL SETSCREWS AND LOCKS TO PREVENT LOSS DURING SHIPPING

866.652.2100

Setup Instructions:

- A) Use standoff screws to secure the front panel with door and back panel of the pedestal to the side panels.
- B) After assembling front, back, and side panels, slide floor into the bottom of the pedestal. The floor will sit on pins on the inside of the side panels.
- C) After floor is in place, use velcro attachments to install shelf.

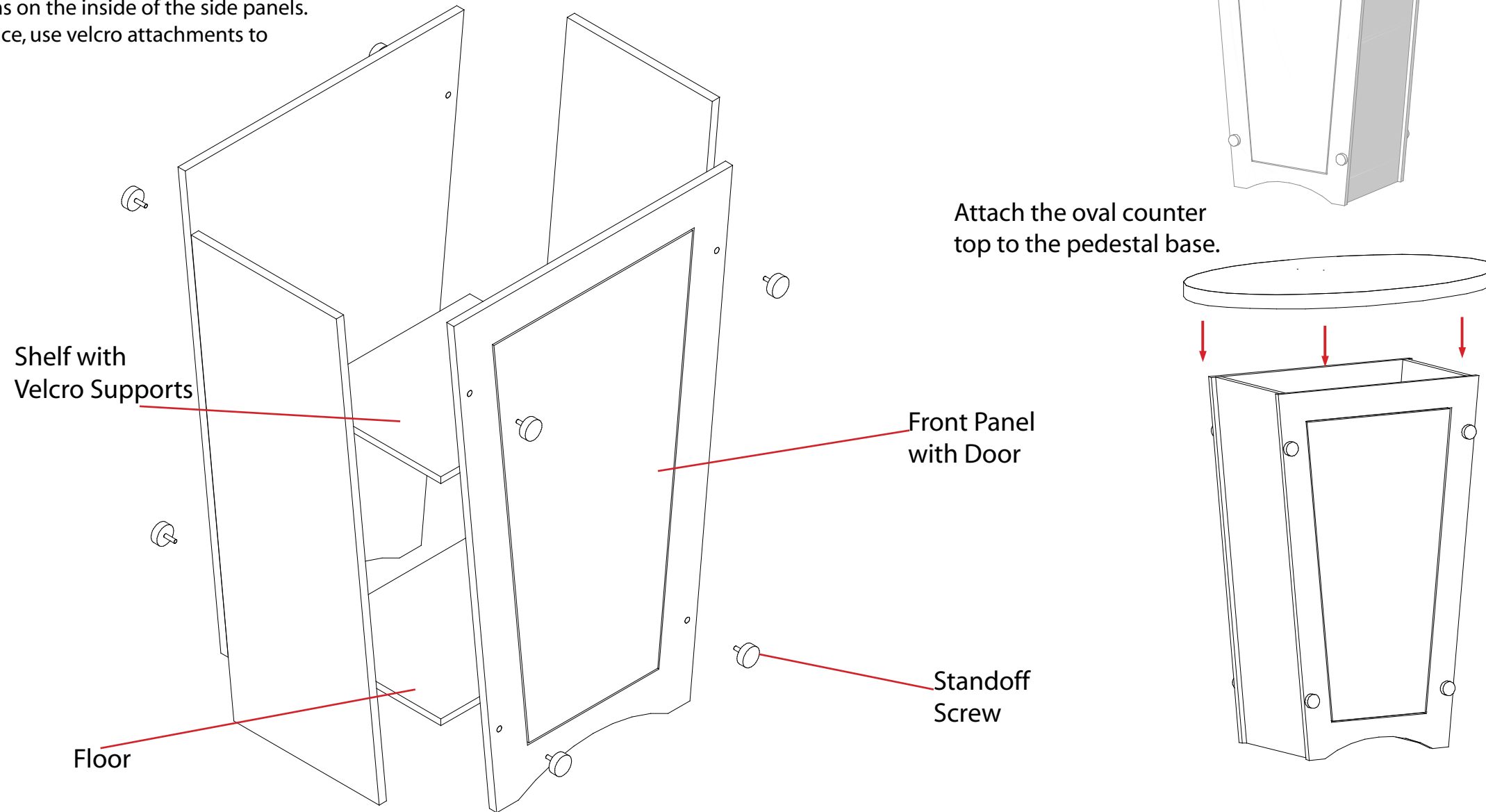

WHEN DISASSEMBLING ALUMINUM EXTRUSION, TIGHTEN ALL SETSCREWS AND LOCKS TO PREVENT LOSS DURING SHIPPING

Top View of each Level

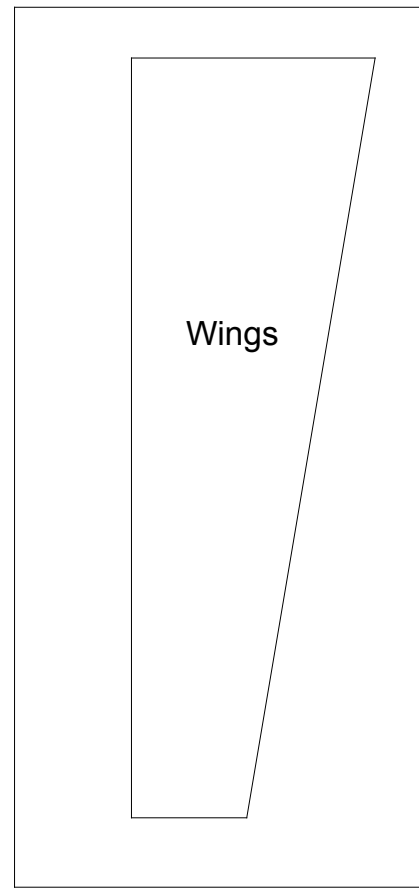

Level 1 (Bottom)

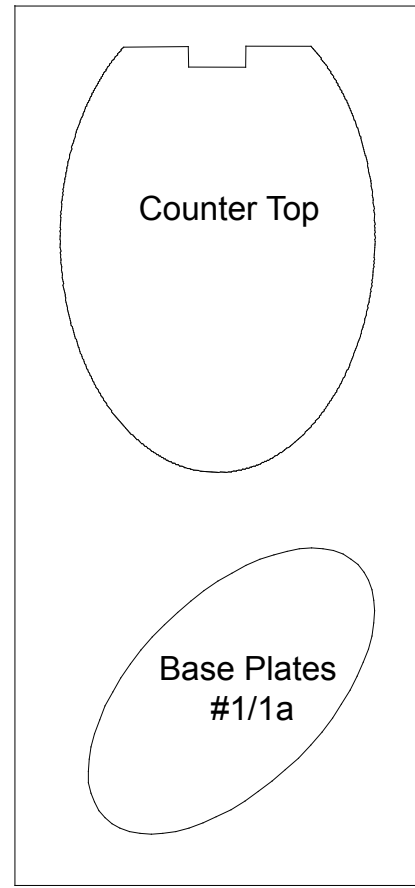

Level 2

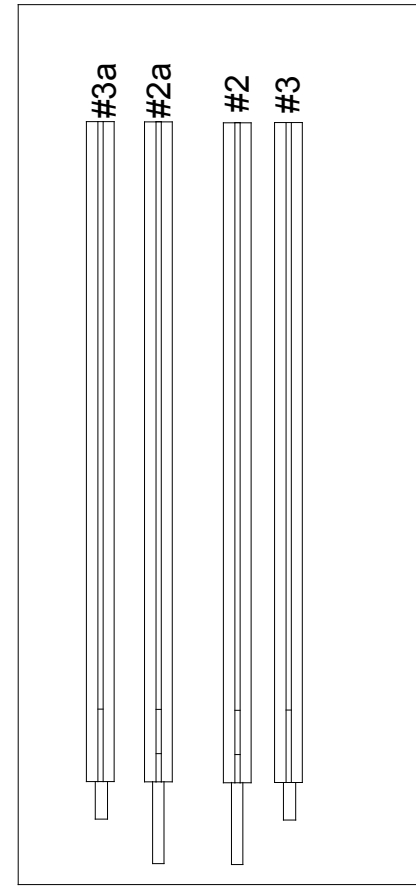

Level 3

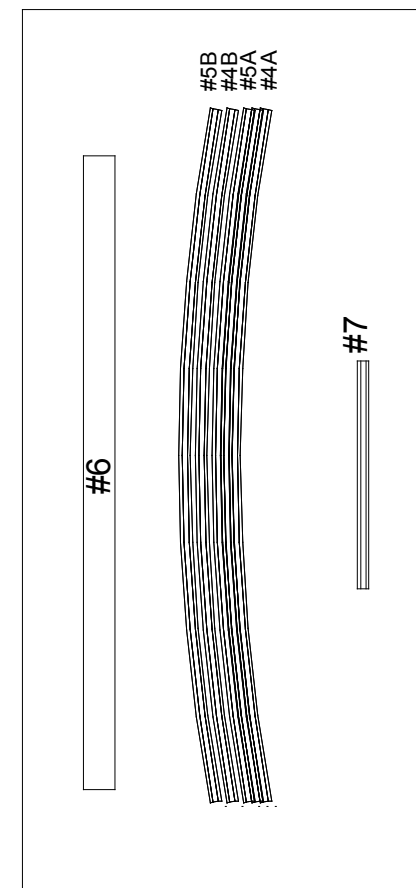

Level 4

Setup Hardware

Halogen Lights

WHEN DISASSEMBLING ALUMINUM EXTRUSION, TIGHTEN ALL SETSCREWS AND LOCKS TO PREVENT LOSS DURING SHIPPING

Top View of each Level

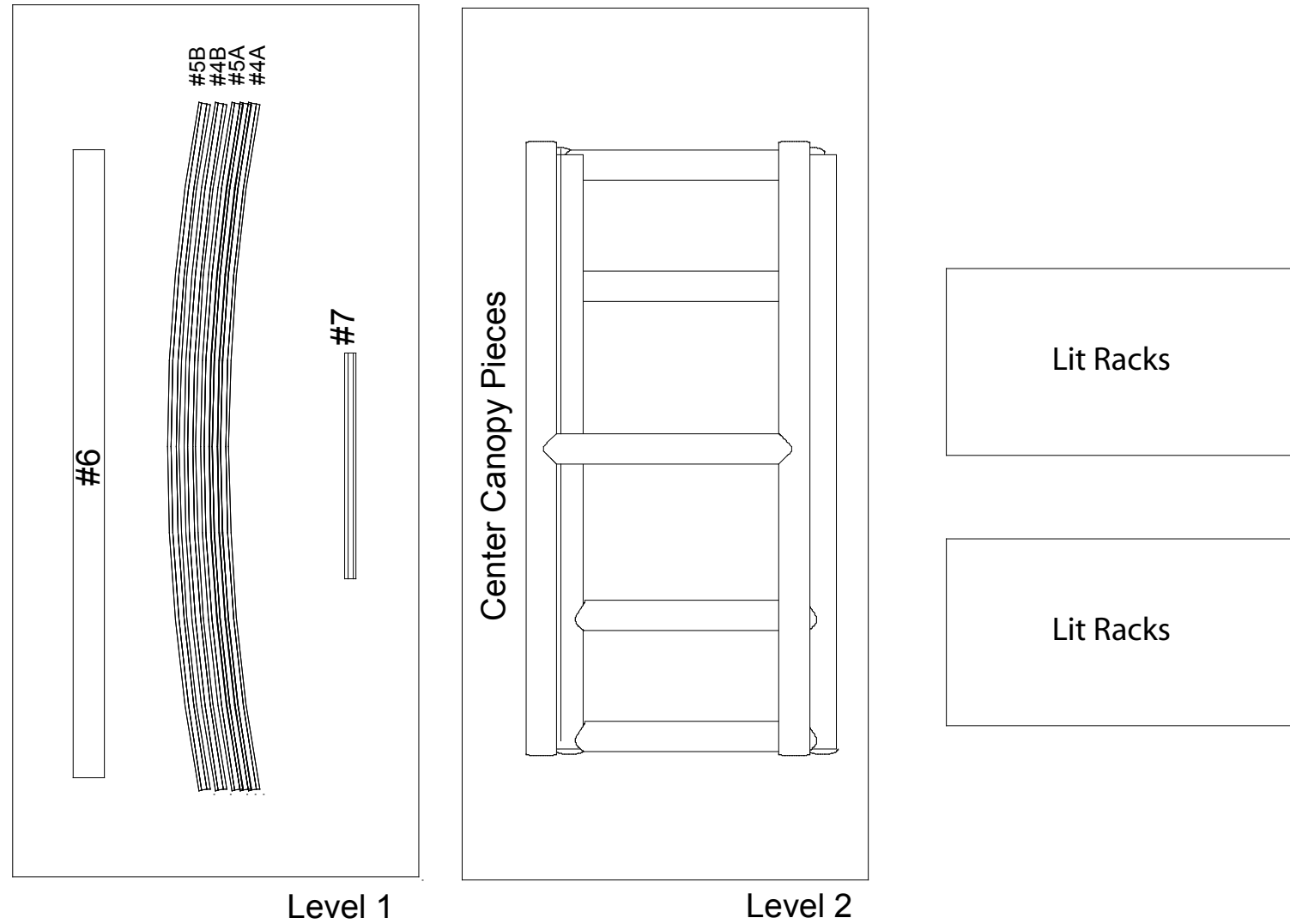

WHEN DISASSEMBLING ALUMINUM EXTRUSION, TIGHTEN ALL SETSCREWS AND LOCKS TO PREVENT LOSS DURING SHIPPING

Top View

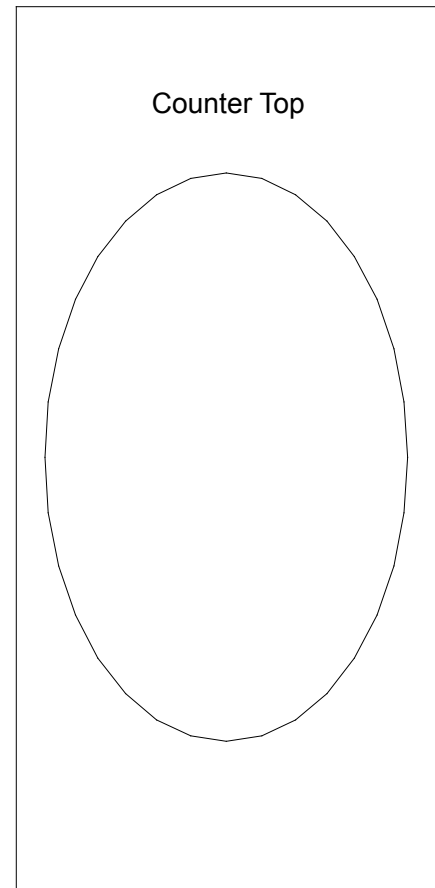

Level 1

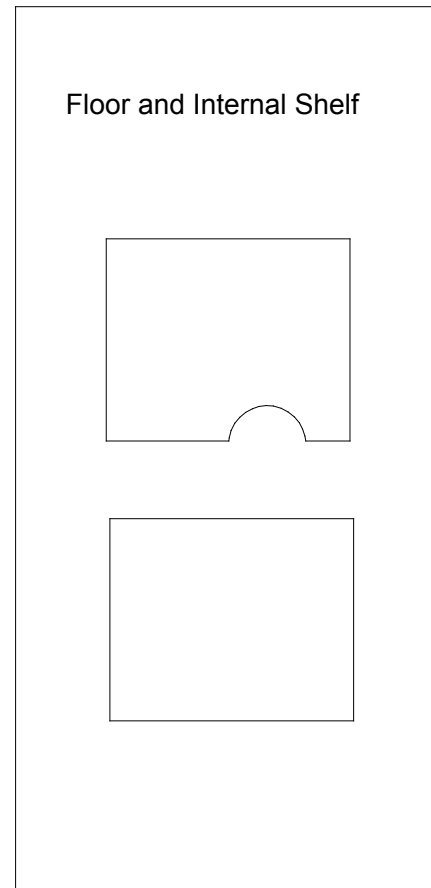

Level 2

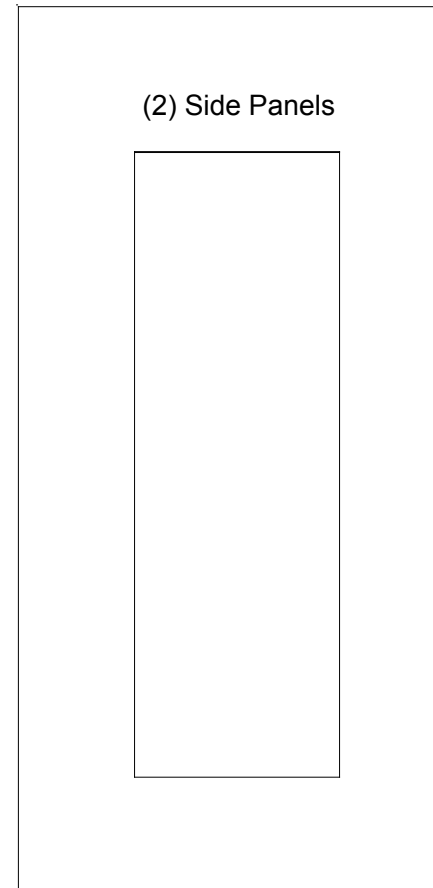

Level 3

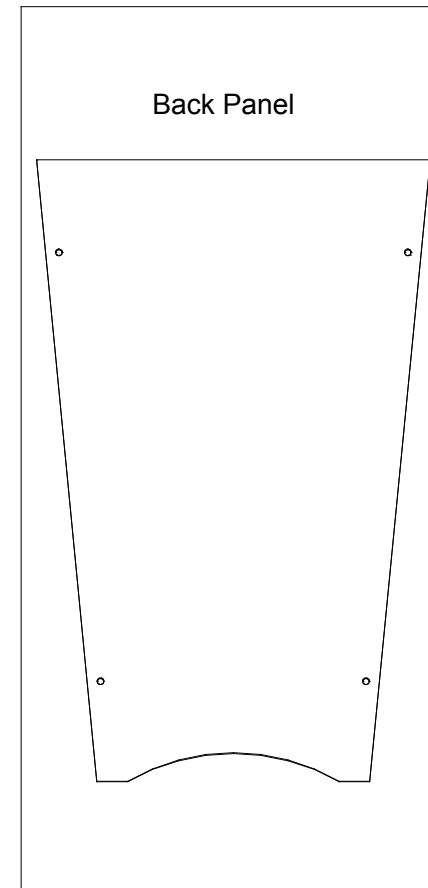

Level 4

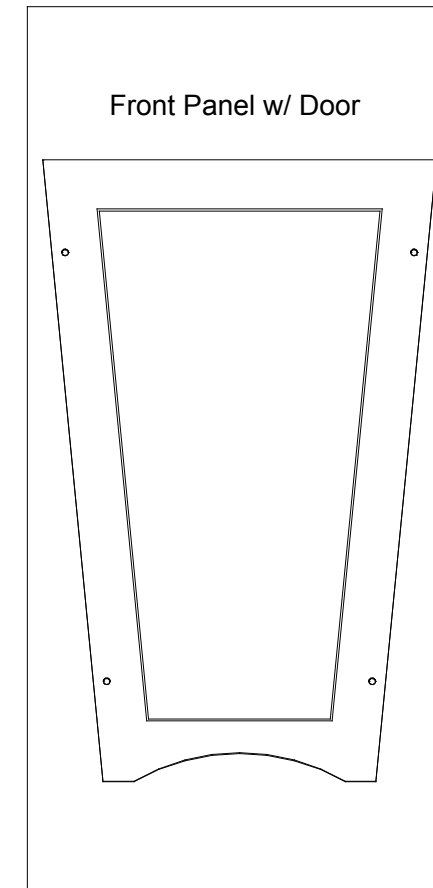

Level 5

WHEN DISASSEMBLING ALUMINUM EXTRUSION, TIGHTEN ALL SETSCREWS AND LOCKS TO PREVENT LOSS DURING SHIPPING