

Plan View

10'

10'

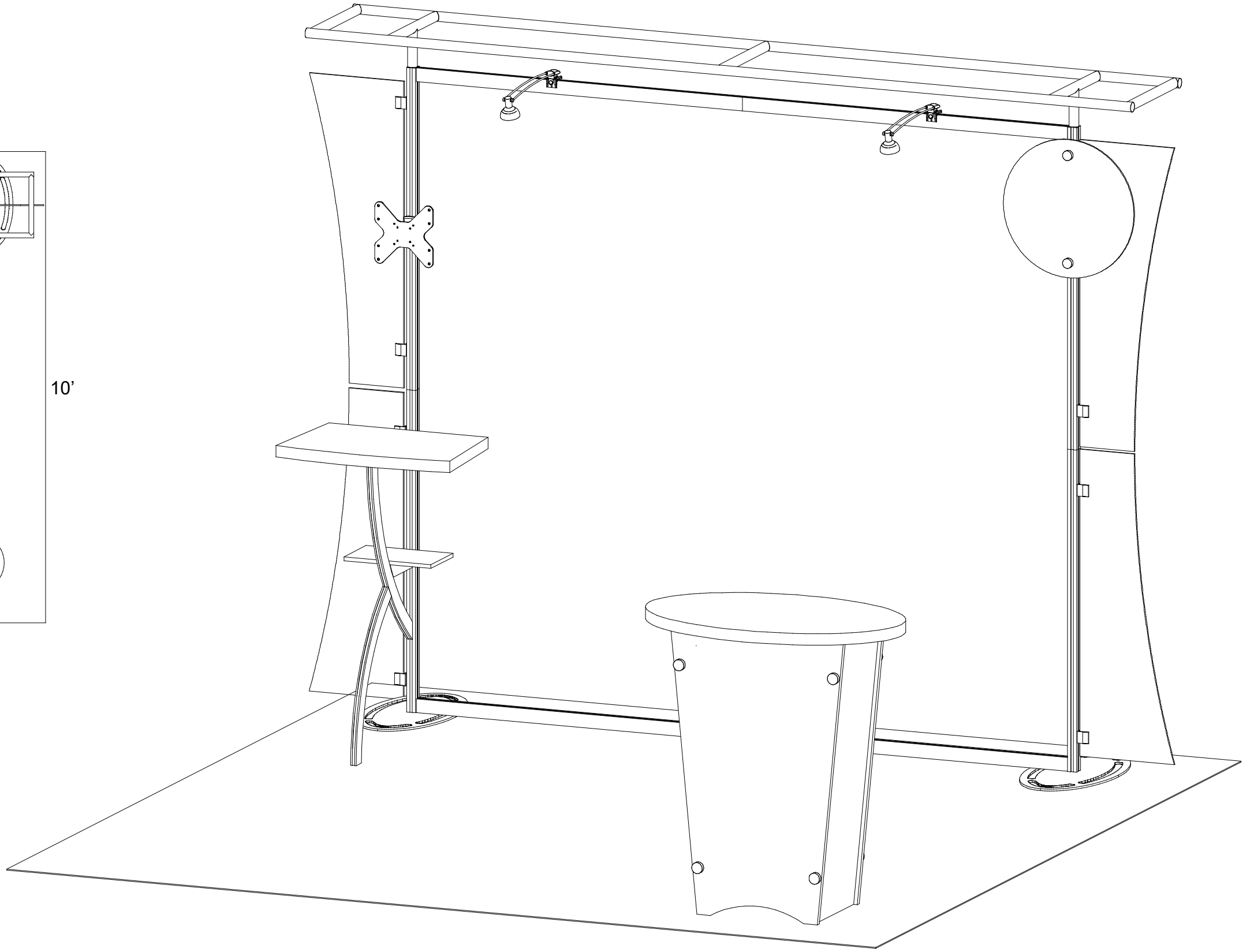

SETUP INSTRUCTIONS

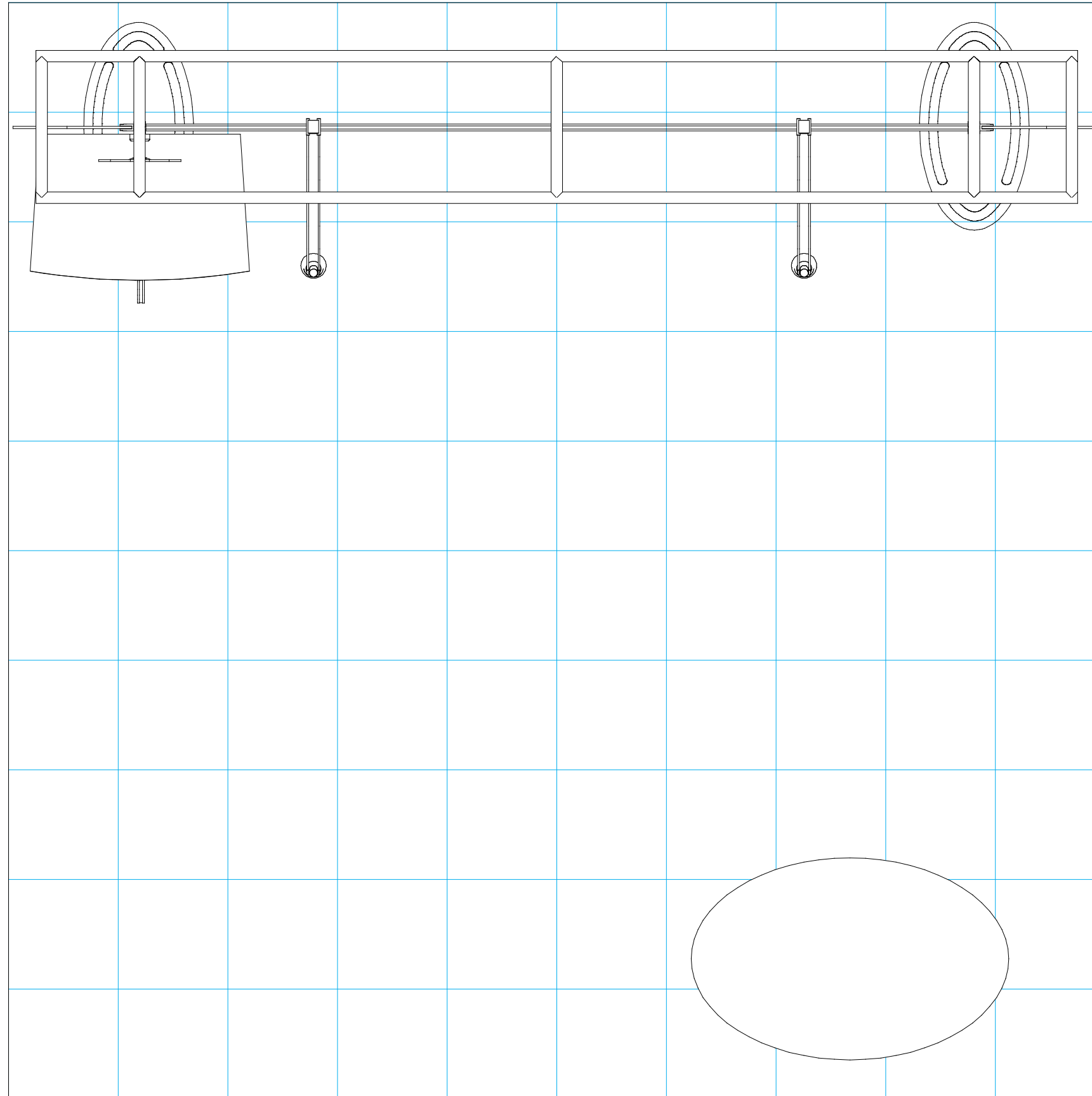

= 1 sq foot

General Setup Instructions

- Read entire setup instruction manual prior to unpacking parts and pieces.
- The setup instructions are created specifically for this configuration.
- Setup instructions are laid out sequentially in steps, including exploded views with detailed explanation for assembly.

Cleaning & Packing

- For Cleaning Metal, Plex, & Laminate Parts: Use a **MILD NON-ABRASIVE** cleanser and soft cloth/paper towel to clean all surfaces.
- Keep exhibit components away from heat and prolonged sun exposure.
Heat and UV exposure will warp and fade components.
- Retain all provided Packing Materials. All provided packing materials are for ease of repacking & component protection.

Disassembly

- For loss prevention, tighten all set screws and locks during disassembly.



Hex Tool - Essential for Assembly

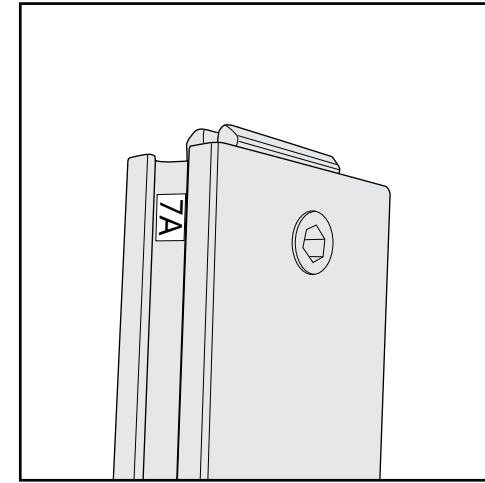

Part Identification - Numbering



Spline Connection



Base Plate & Extrusion Connection



Extrusion & Lock Connection



Engaged Lock



WARNING



DO NOT USE POWER TOOLS



LADDERS OR LIFTS
MAY BE REQUIRED



ALL CONNECTIONS MUST
BE TIGHTLY SECURED



1) Mounting plate & wing nuts, in packed position.

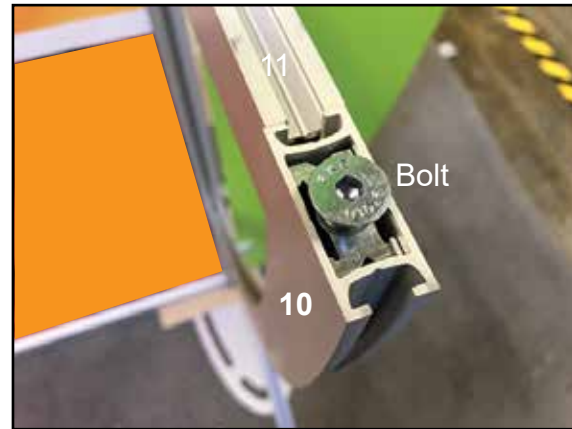

2) Mounting plate bolt in, packed position.

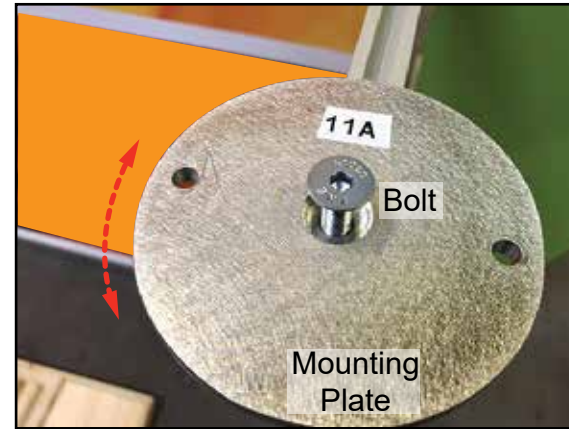

3) Place mounting plate onto [10] then tighten bolt, part way, allowing some rotation for final positioning.

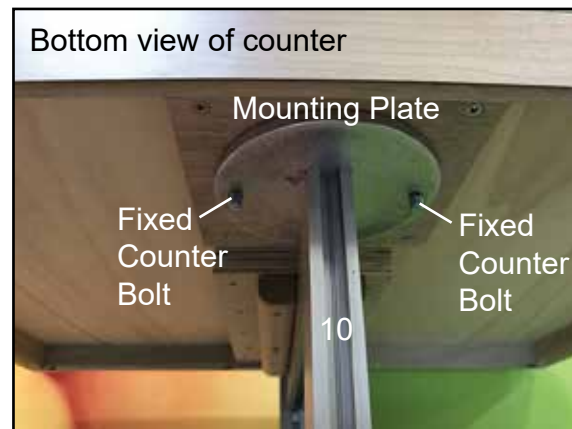

4) Place fixed counter bolts into mounting plate, then lift counter to re-tighten bolt.

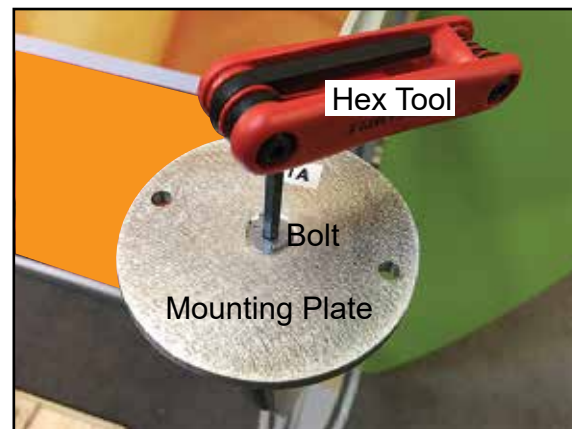

5) Tighten bolt, using hex tool, to secure.

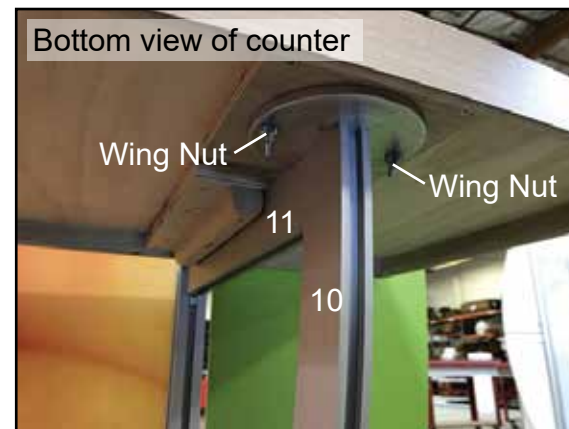

6) Place fixed counter bolts into mounting plate, then secure using wing nuts.

Completed Assembly

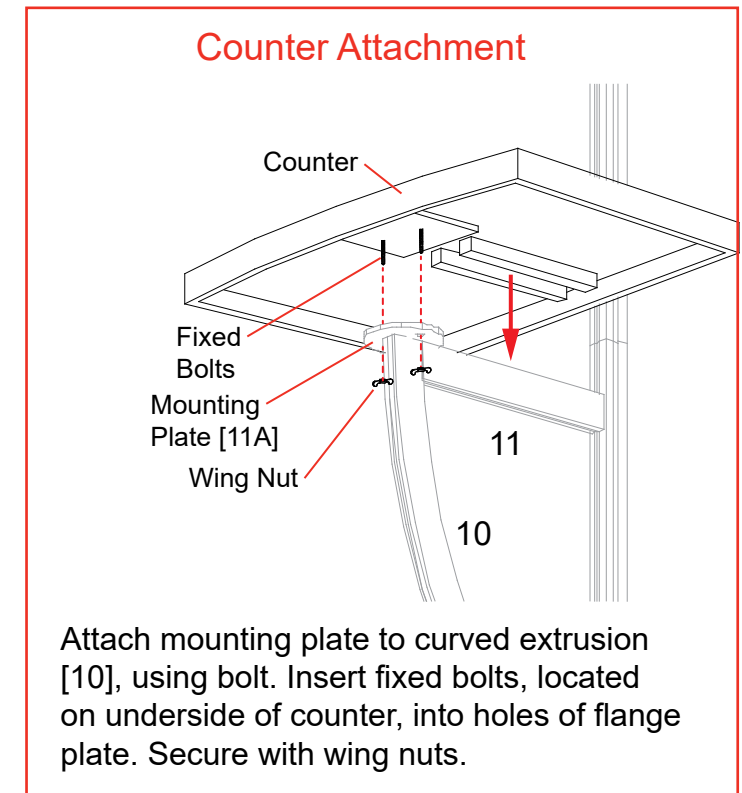

Keep mounting plate [11A] and wing nuts attached to counter, when packing.

Keep bolt attached to [10], when packing.

Top View of Each Level

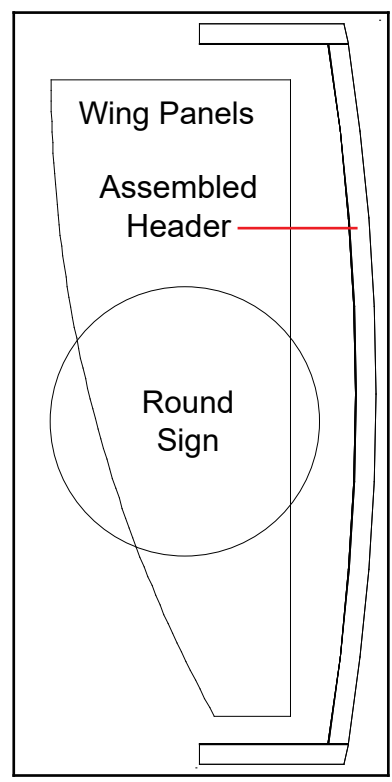

Level 1 (Bottom Level)

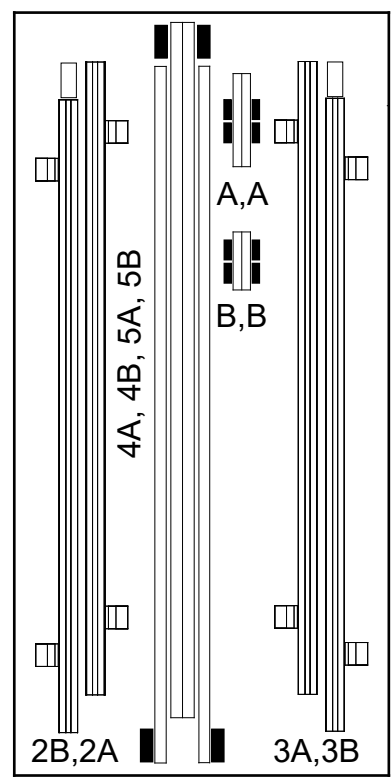

Level 2

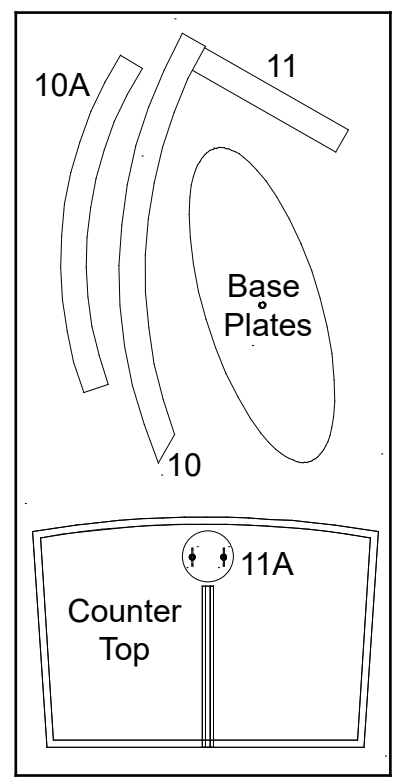

Level 3

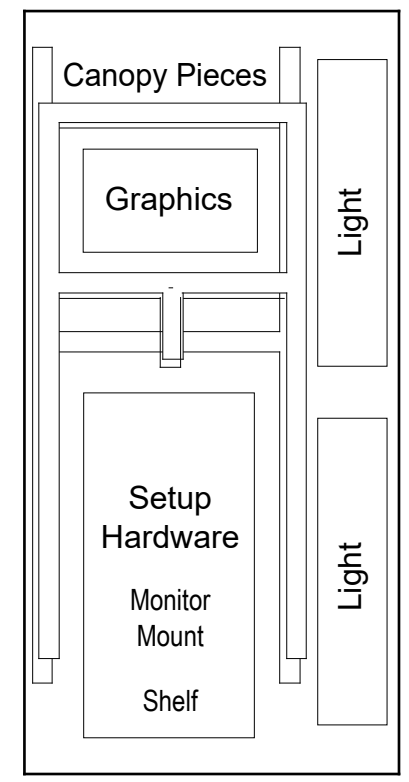

Level 4

Top View of Each Level

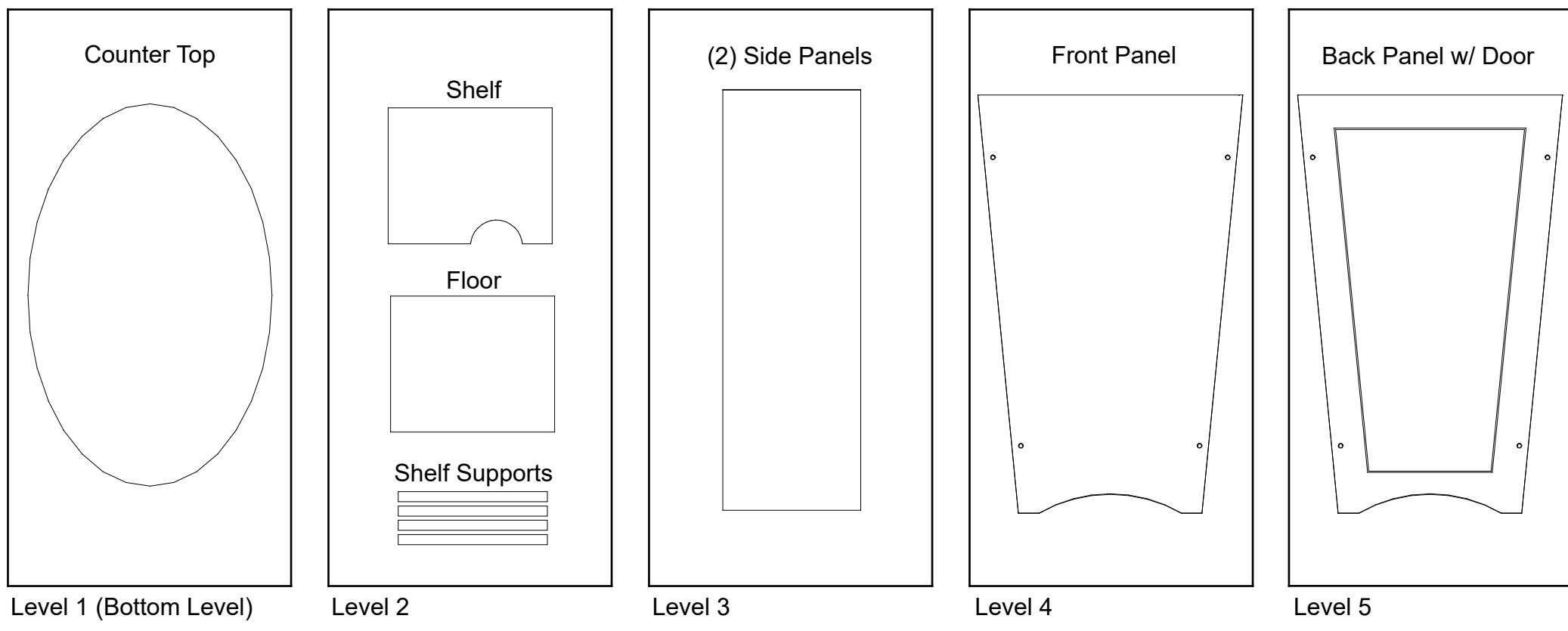

| Item | Qty. | Description |
|-------|------|--|
| 1 | 2 | Base Plate |
| 2A,2B | 1,1 | 42" S40 Vertical Extrusion w/ A10 Clamps |
| 3A,3B | 1,1 | 42" S40 Vertical Extrusion w/ A10 Clamps |
| 4A,4B | 1,1 | 45" Z45 Horizontal Extrusion |
| 5A,5B | 1,1 | 45" Z45 Horizontal Extrusion |

- Steps:
- 1) Attach base plates [1] lower verticals [2A] and [3A], using bolts.
 - 2) Connect verticals [2A to 2B] and [3A to 3B], using connection bars [B].
See [Straight Connection with Knobs](#) detail.
 - 3) Connect horizontals [4A to 4B] and [5A to 5B], using connection bars [A].
See [Straight Connection with Knobs](#) detail.
 - 4) Connect assemblies [2A/2B] and [3A/3B] with assemblies [4A/4B] and [5A/5B].
See [Corner Connection with Knob](#) detail.
 - 5) Attach graphic to Velcro on back of assembled Backwall.

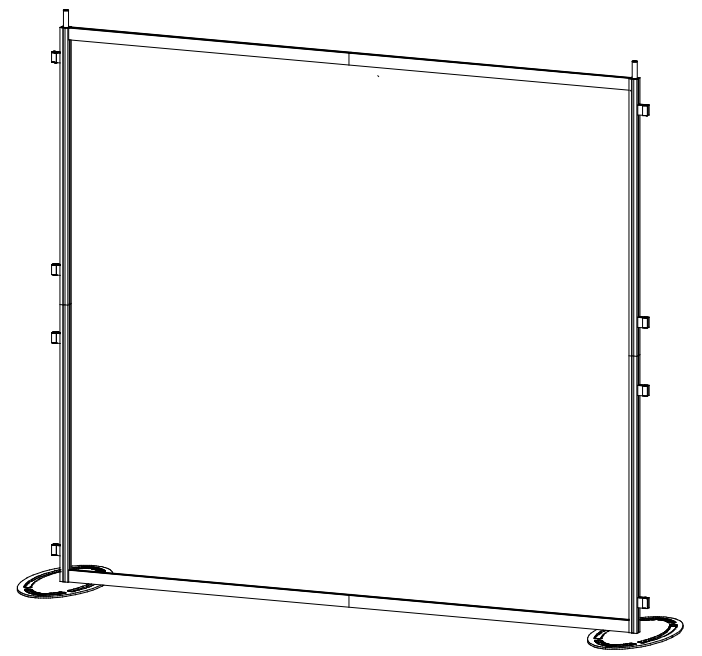

When Assembled

Keep Canopy Mounts attached to [2B,3B].

Keep A10 clamps attached to [2A,2B,3A,3B].

★ **Corner Connection with Knob**



Turn knob clockwise to tighten lock.

Do not over tighten Knobs

◆ **Straight Connection with Knobs**

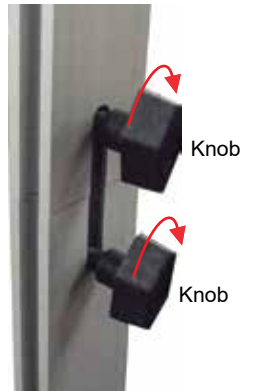

Slide connection bar between extrusions, then turn knobs clockwise to tighten lock.

Do not over tighten Knobs

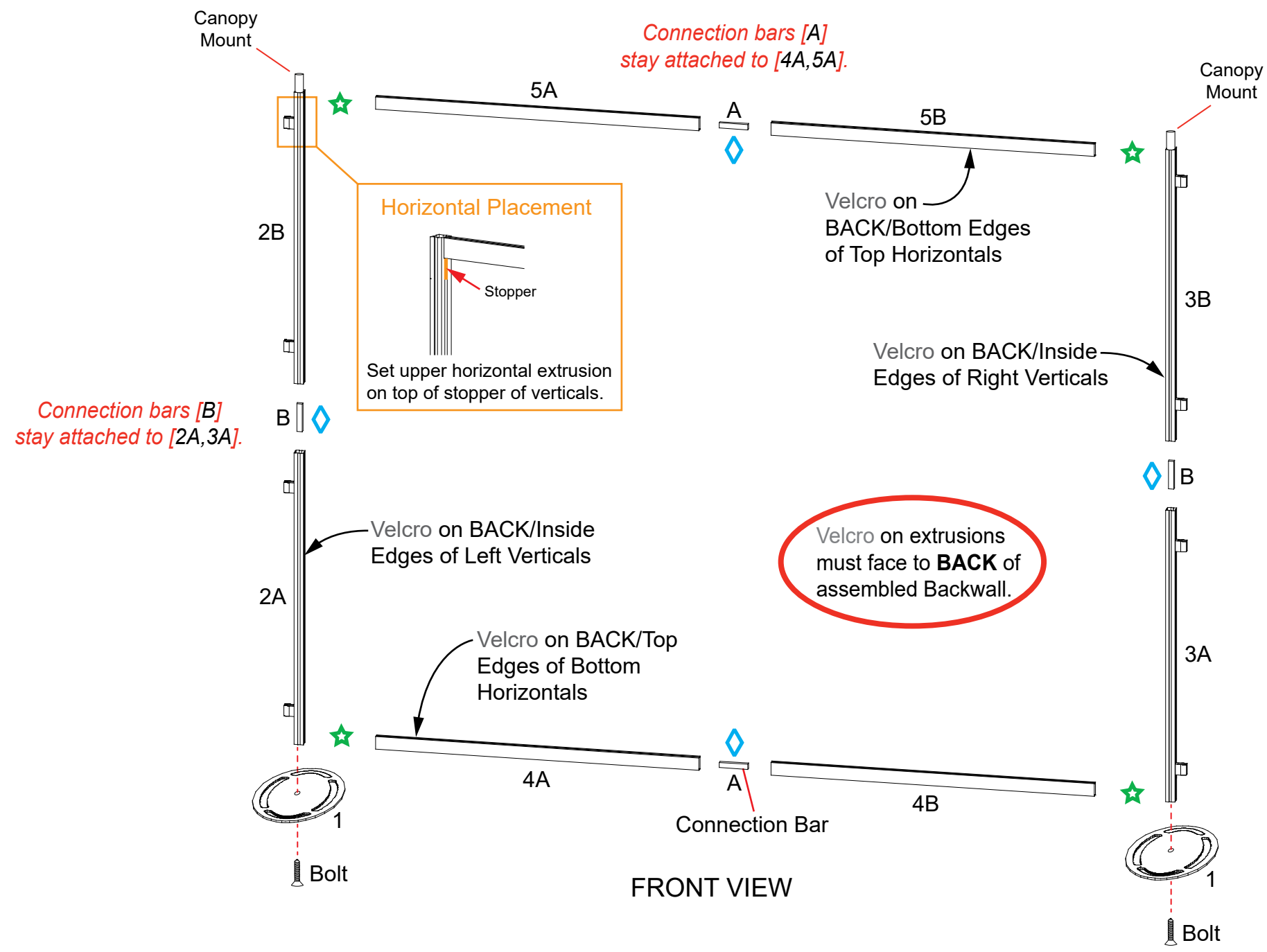

Canopy Mount Attachment

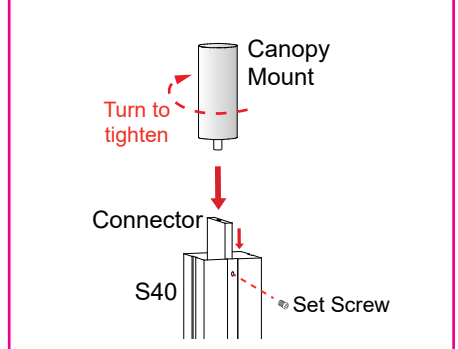

Attach connector to top of vertical extrusion then tighten set screws to secure. Insert canopy mount into threaded hole in top of connector then turn canopy mount clockwise to tighten in place.

Steps:

- 1) Connect lights to top horizontal extrusions [5A/5B]. See **Light Connection** detail.
- 2) Attach extrusions [10/11] and shelf to vertical [2A].
- 3) Attach support leg [10A] to curved extrusion [10].
- 4) Attach flange plate [11A] to top of curved extrusion [10], using bolt.
- 5) Attach counter top to counter mounting plate [11A]. See Counter Assembly page.
- 6) Attach Wings to A10 clamps. See **Clamp Attachment** detail.
- 7) Attach Monitor Mount to vertical [2B]. See **Monitor Mount Attachment** detail.
- 8) Attach Sign to vertical extrusion [3B]. See **Sign Attachment** detail.

| Item | Qty. | Description |
|------|------|------------------------------|
| 10 | 1 | 30.2" Curved Extrusion |
| 10A | 1 | Support Leg |
| 11 | 1 | 12.184" Horizontal Extrusion |
| 11A | 1 | Counter Mounting Plate |

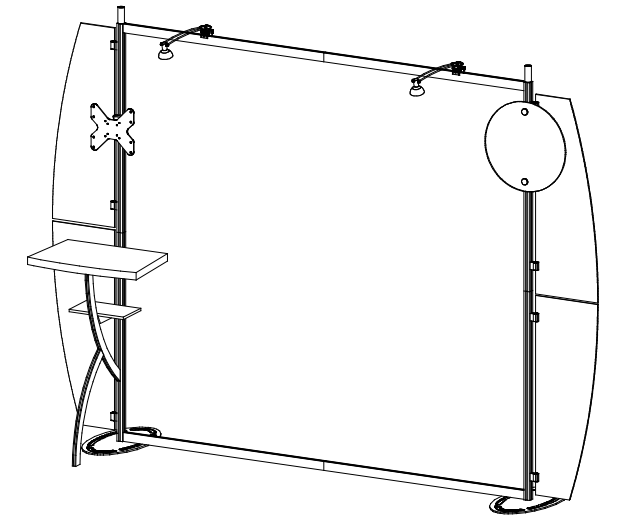

When assembled

*** Monitor Mount Attachment**

Slide V4 Connectors into groove of Extrusion. Tighten Set Screws to secure connectors in place.

Attach Monitor Mount back piece to Extrusion, using bolts.

Then slide monitor mount into back piece.

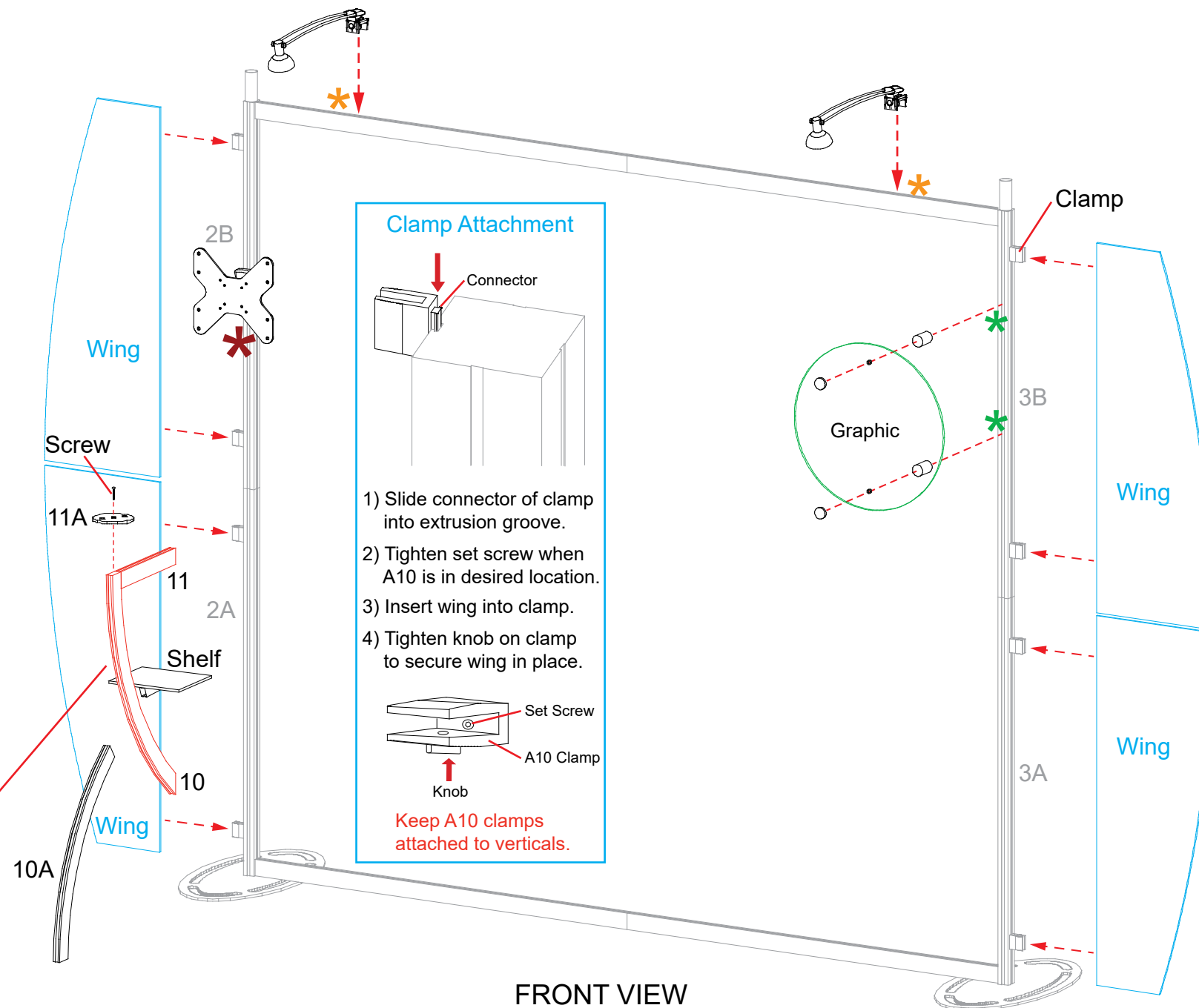

FRONT VIEW

*** Light Connection**

Slide light onto clip then lock clip into groove of horizontal extrusion.

*** Sign Attachment**

Slide connector into groove of extrusion. Tighten set screws to secure in place. Screw standoff into connector. Place sign between standoff and cap then tighten cap to secure sign.

Keep curved extrusion [10] & horizontal [11] assembled.

AERO

- Steps:
- 1) Connect canopy pieces together as shown.
 - 2) Apply pillow case graphic to assembled canopy.

Using Your Setup Instructions

The Aero Setup Instructions are created specifically for your configuration. The instructions include an exploded view of the frame which is sequentially labeled. We encourage you to review the instructions before attempting to assemble your exhibit.

Connections are kept very simple; no tools required. Everything assembles with push-button connectors.

Cleaning and Packing Your Display

- 1) Use care when cleaning aluminum extrusion or acrylic inserts. Use only non-abrasive cleaners.
- 2) Retain all packing material. It will make re-packing much easier and will reduce the likelihood of shipping damage.

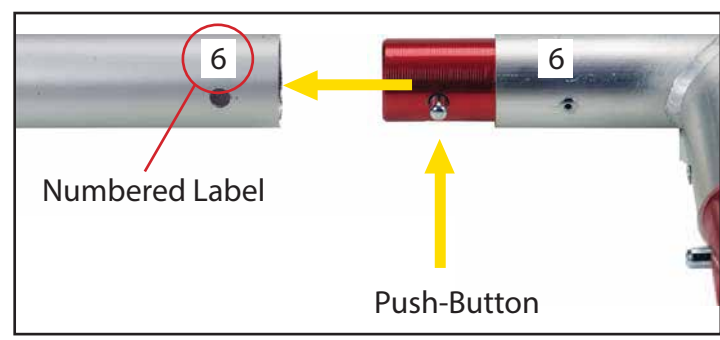
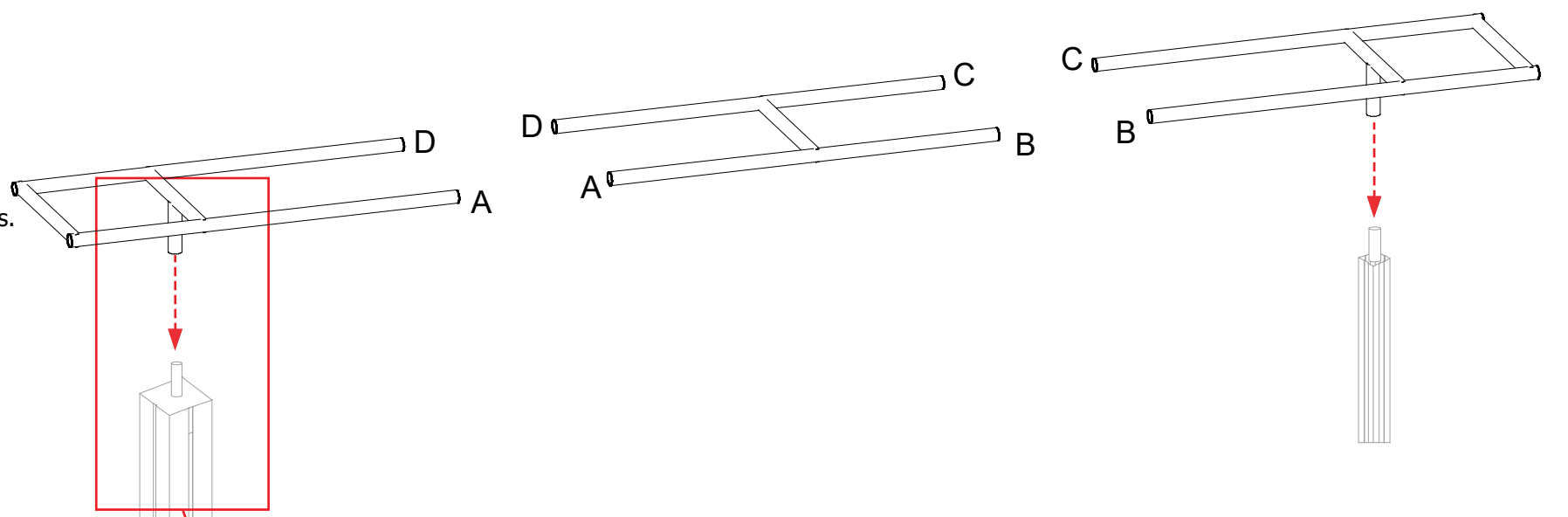

Connections are made by holding the button down and sliding the red tube into opposing tube until button locks into the hole of the opposing tube. To disassemble, push button and pull or twist extrusions apart.

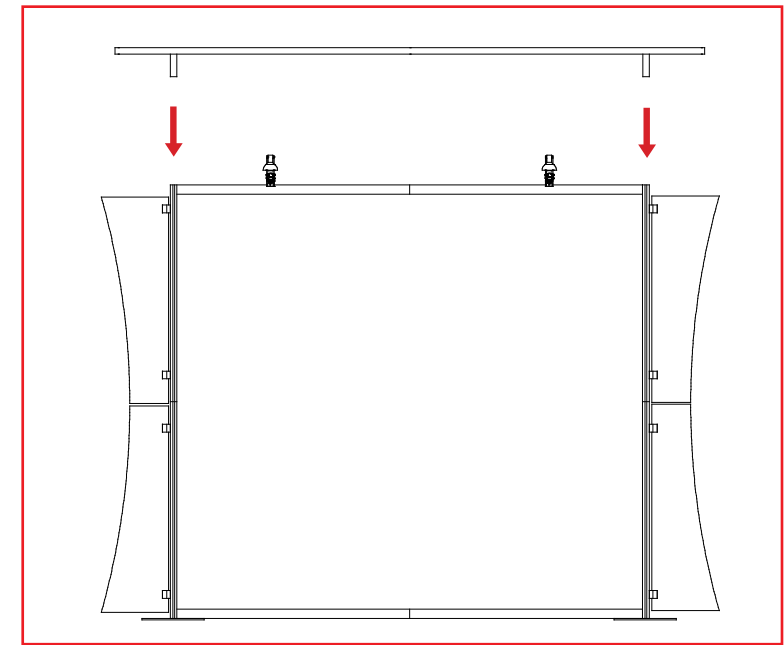
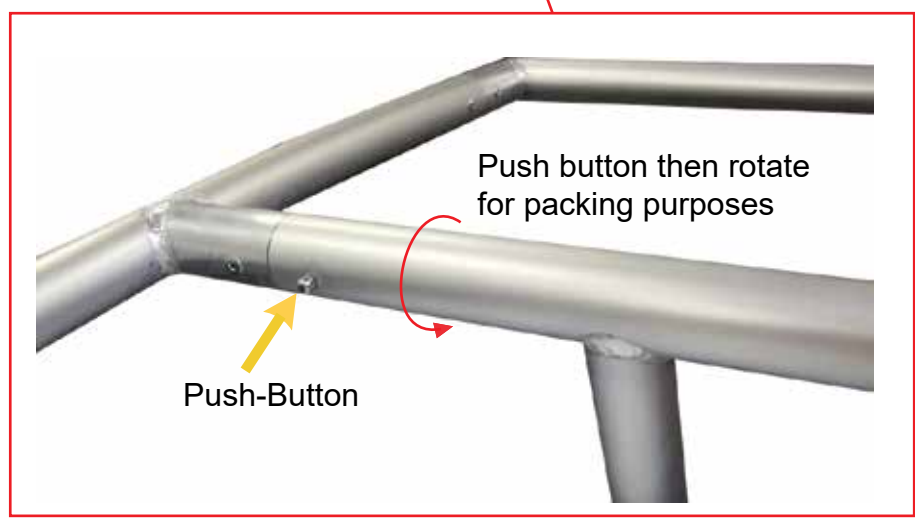
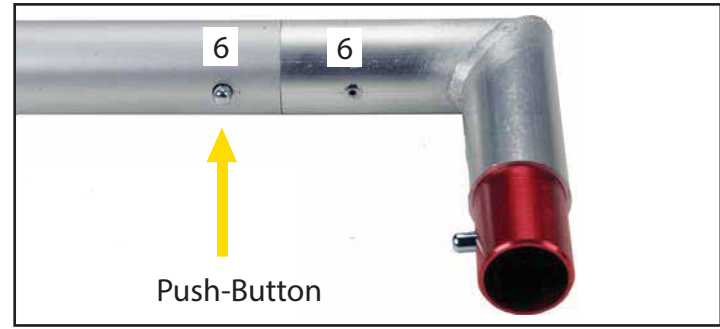

Setup Instructions:

- 1) Attach pins at bottom interior of side panels. *Note: Pins are designed to be slightly angled.*
- 2) Use screw caps to secure the side panels to front panel and back panels, making sure Velcro is facing inward.
- 3) Slide floor into the bottom of assembled pedestal base. The floor will sit on pins of the side panels.
- 4) Connect shelf supports to Velcro on panels, then place shelf on top of supports.
- 5) Attach pedestal top to assembled pedestal base. See Pedestal Top Attachment detail.

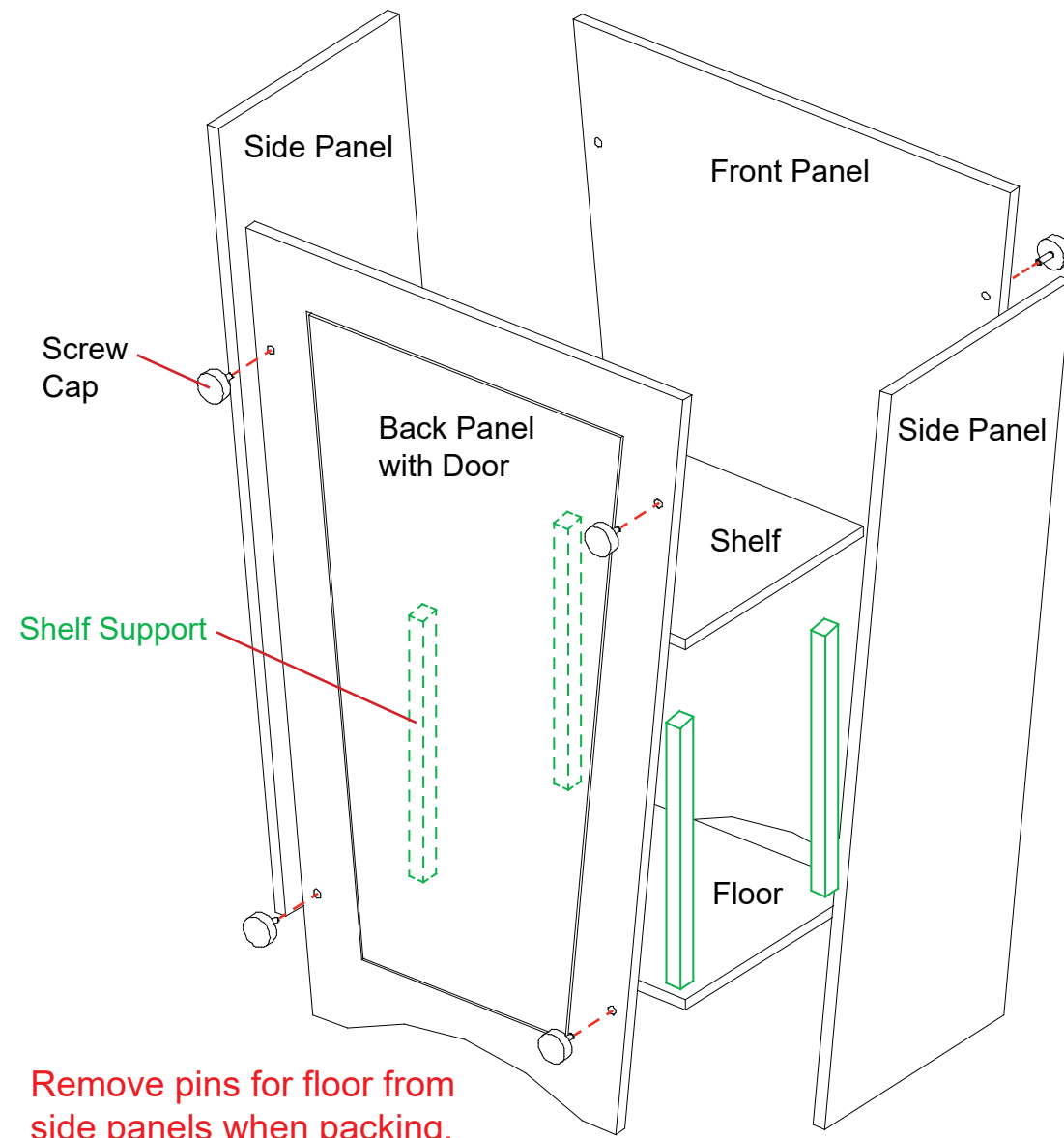

Pedestal Base Assembly

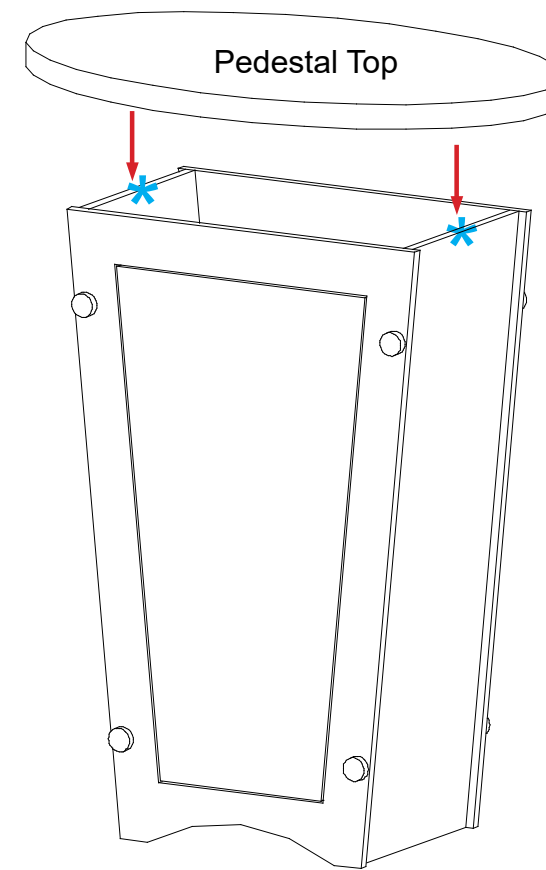

Pedestal Top Attachment

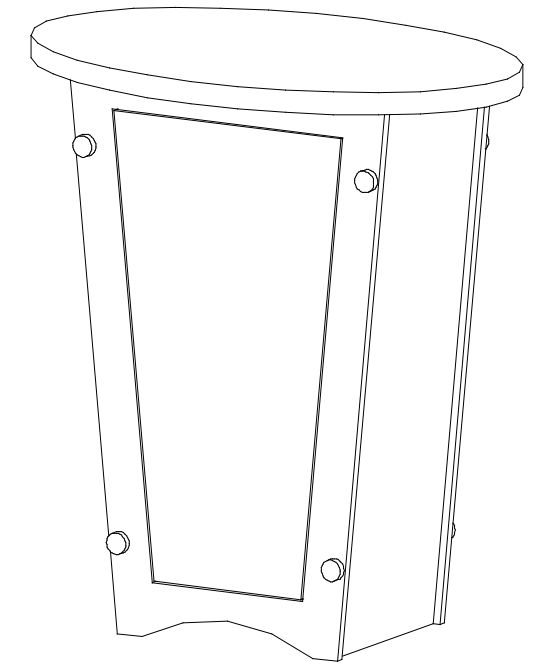

Completed Pedestal Assembly

